



Operating instructions

(Translation of the original operating instructions)

dustoo

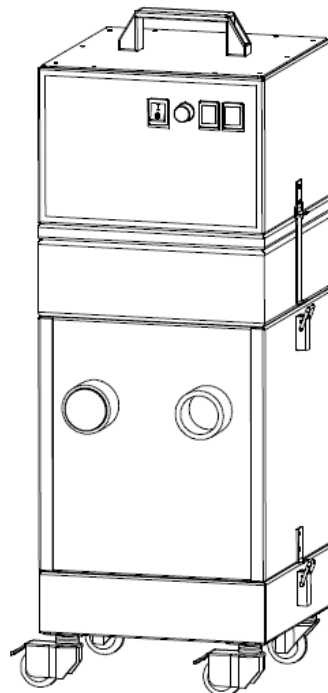



Table of contents

1. General	3
2. Description of the system elements	4
2.1. Illustration of the system elements	4
2.2. Functionality of the system	5
2.3. Intended use	5
2.4. Residual risk	5
3. Safety instructions	6
3.1. Definition of the hazard symbols	6
3.2. General safety instructions	6
4. Storage, transport and installation of the device	7
5. Commissioning	8
5.1. Connecting an extraction element	8
5.2. Electrical connection	8
5.3. Connecting the compressed air supply	9
5.3.1. Compressed air supply for the cleaning of the filter cartridges	9
6. Operating the system	10
6.1. Explanation of the operating elements	10
6.2. Setting the automatic filter cartridge cleaning	11
7. Maintenance	12
7.1. Reset to maintenance state	13
7.2. Cleaning the filter cartridges	13
7.3. Replacing the filter cartridges	14
7.4. Emptying the dust collecting tank	15
7.5. Replacing the carbon brushes	15
8. Dismantling / Disposal	16
9. Diagnostics and troubleshooting	17
10. List of spare parts	17
11. Technical data	18
12. EC declaration of conformity	19
13. Training protocol	20
14. Maintenance intervals	21
14.1. Usage-related maintenance	21
14.2. General maintenance	21
14.2.1. Visual inspection of the device	22
14.2.2. Functional test of the device	22
14.2.3. Electrical test of the electrical lines and earthing connections	23

1. General

Congratulations on purchasing the product from TEKA.

Our engineers ensure that our devices reflect the state of the art through continuous development. Nevertheless, misuse or misconduct can endanger your safety. Please observe the following for a successful use of the device:

	<p>Only authorised and instructed personnel can carry out transport, operation, maintenance and repair of the device. The operator must ensure that the operating personnel take note of these instructions.</p> <p>Please read these instructions before operating the device, and observe the safety precautions to avoid injury!</p> <p>Store this manual in a safe place! These instructions are to be regarded as a component of the product!</p> <p>Adhere to all product notes!</p> <p>Modifications or conversions that the operator carries out at the device without the consent of the manufacturer, can lead to new safety hazards or to the loss of warranty claims.</p> <p>Observe the manufacturer's instructions. Contact the manufacturer in case of any uncertainty: Tel: +49 2541-84841-0 E-mail: info@teka.eu</p>
---	---

2. Description of the system elements

2.1. Illustration of the system elements

Installation example:

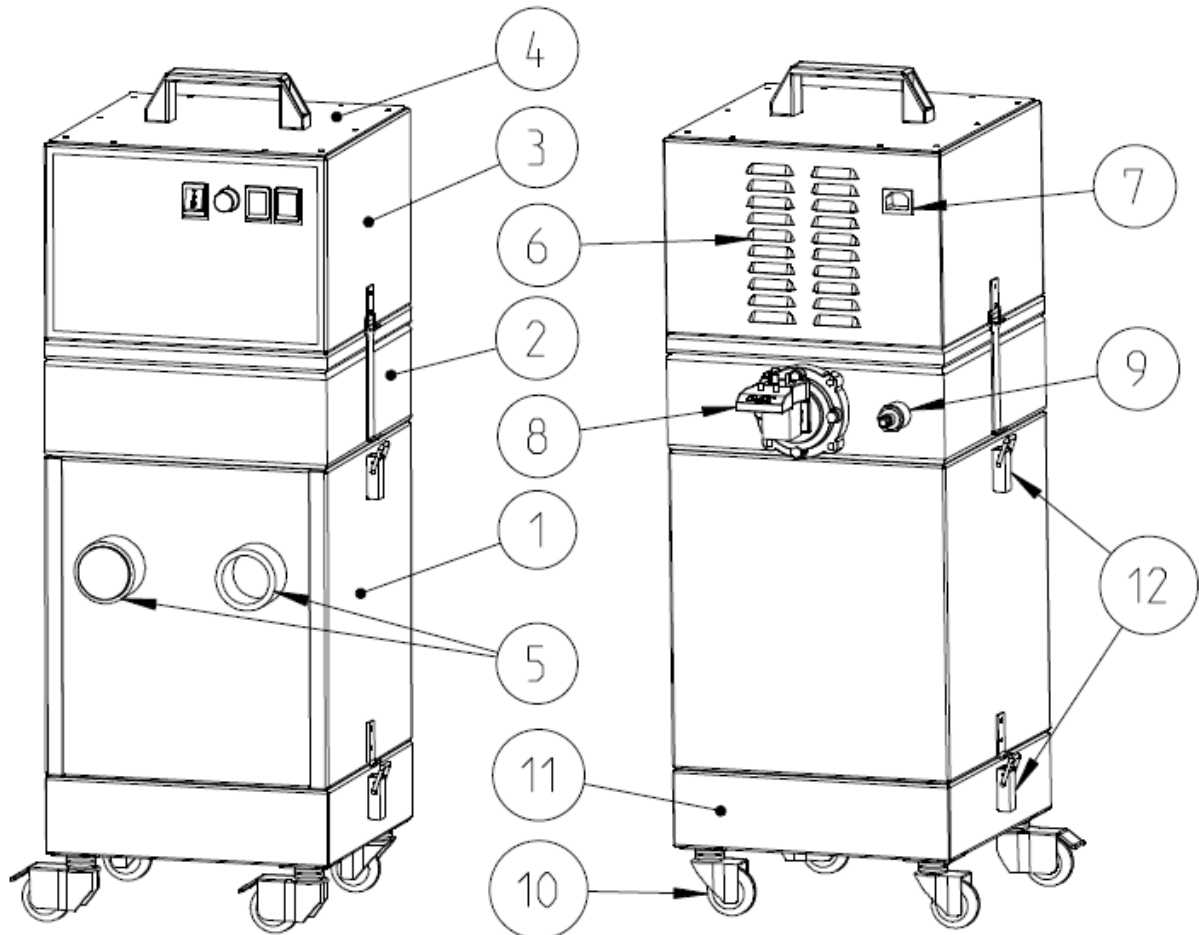

Z.Nr. 12473703

Pos.1	Filter housing	Pos.8	Clock generator
Pos.2	Cleaning housing	Pos.9	Connection for compressed air
Pos.3	Turbine housing	Pos.10	Swivel castor
Pos.4	Cover plate	Pos.11	Dust collecting tank
Pos.5	Suction nozzle	Pos.12	Toggle lever
Pos.6	Exhaust grille		
Pos.7	Connection for mains cable		

2.2. Functionality of the system

The filter unit serves to suck off and filter polluted air (according to the intended use). The air is purified on the surface of the filter cartridge in the filter section of the unit. The separated dust is collected in a dust collecting tank. An automatic filter monitoring indicates when a cleaning or a replacement of the filters is necessary. The purified air is led back into the working room via an exhaust air grille.

2.3. Intended use

The device is intended for commercial use. If the device is made publicly accessible, it must never be operated unsupervised by authorized personnel, authorized by the operator.

The filter unit is mainly used to extract and filter dust and fumes.

	WARNING
	<p>Improper use can damage parts and be a danger to life and limb! The device must not be used for the extraction of oil-laden welding fume, explosive dust and gases, hybrid mixtures, glowing or burning substances, gases, water, etc. The device must not be operated in explosive zones.</p> <hr/> <p>Dangers arising from fire. If the sucked medium is combustible fume or dust, the operator must determine beforehand which fire protection measures are to be taken.</p>

2.4. Residual risk

	CAUTION
	<p>Danger due to possible hazardous materials in the exhaust air flow. Because the unit does not monitor the quality of the air in the exhaust air flow, we recommend that you always guide the exhaust air flow exiting our unit to areas (e.g. to the outside into the open air) in which there is no danger to any living being. To do this, it is necessary to fit a suitable exhaust air line at the filter unit.</p>

3. Safety instructions

3.1. Definition of the hazard symbols

The device is constructed according to the state of the art and the recognised safety regulations. Nevertheless, during use threats to life and limb of the user or other persons may arise. The impairment of the machine or other property are also possible. In these instructions we warn by using corresponding indications.

	WARNING
	WARNING These instructions are made in case of risks that can lead to <u>injury or death</u> .

	CAUTION
	CAUTION These instructions are made in case of risks that can lead to <u>injury</u> .

	NOTICE
	NOTICE These instructions are made in case of risks that can lead to <u>material damages</u> .

	Information notes are no hazard warnings; they call attention to useful information.
---	--

3.2. General safety instructions

	WARNING
	Dangers arising from improper use / unauthorised operations. The operator must ensure that their authorised personnel are familiar with all the safety indications in this manual in advance. The operator is responsible for ensuring that all work is carried out by authorised and qualified personnel. We therefore recommend using the training protocol on the last page for that purpose (see chapter "Training protocol"). Laymen are allowed to operate the device after having received the necessary instructions. But they are not allowed to carry out any installation, repair or maintenance work. <hr/> Dangers arising from fire. In case of fire, if possible, switch the unit immediately off or disconnect it from the power supply. Fire extinguishing measures which the operator is obliged to determine beforehand must be initiated immediately.

	WARNING
	<p>Dangers arising from electricity. The operator must ensure that electrical plants and equipment are only built, modified and maintained by a qualified electrician or under the direction and supervision of a qualified electrician. Do not work on components if you are not sure that these are disconnected. If necessary, disconnect the device from the electric power supply and secure it against unauthorized restarting.</p>

4. Storage, transport and installation of the device

	WARNING
	<p>Risk of injury from tilting or unmounted components when stored or transported. The device must be secured against tilting and slipping when it is stored or transported. Do not stand under or next to the floating load. Lift trucks, forklift trucks and transport cranes must have a sufficient minimum load bearing capacity. Pay attention to uneven grounds during the transport. Avoid jerky pushing.</p> <hr/> <p>Dangers arising from tilting or functional impairments at its destination. The unit may only be set up on a suitable surface. The surface must be vibration-free and horizontal. The operator must check the bearing capacity of the surface. As soon as the unit has reached its intended destination, the brakes of the castors must be activated.</p>

	NOTICE
	<p>Damage or functional impairment of the unit due to climatic influences. The unit must be stored in a dry place and protected against moisture during transport. As a matter of principle, the filter unit is not designed to be installed outside.</p>

5. Commissioning

	WARNING
	Dangers arising from a defective condition of the unit. Make sure that the measures described in this chapter are completed before the commissioning of the unit. All doors of the unit must be closed and all necessary connections must be attached before turning the unit on. Do not operate the unit if any components are defective, missing or damaged. Check the orderly condition of the unit before switching it on. The unit must not be operated without a filter element.

	NOTICE
	Damaged supply lines. Make sure that the supply lines are protected against damage by forklift trucks and similar events. Protect all supply lines from heat, moisture, oil and sharp edges.

5.1. Connecting an extraction element

For extracting the contaminated air - according to the intended use - the provided extraction element (e.g. suction arm, suction hose, ...) must be connected at the suction nozzle (see chapter 2.1).

If one extraction hose is used, the supplied cap must be mounted on the unused intake nozzle. Otherwise, false air would be sucked in through this intake nozzle and the extraction capacity would be unnecessarily reduced.

5.2. Electrical connection

	CAUTION
	Health hazard arising from unintentional cleaning processes. Switch on the control only if the unit is in operational condition.

	NOTICE
	Electric malfunction possible in cause of an incorrect power supply. Pay attention to the admissible supply voltage. Please observe the specifications on the type plate.

- Reconnect the mains cable (see chapter 2.1) to the power supply.

5.3. Connecting the compressed air supply

	NOTICE
<p>The compressed air must be dry and oil-free. According to ISO 8573-1:2010 the compressed air quality must at least meet: [7:4:4]</p> <ul style="list-style-type: none">→ Partikle size: <40µm→ Pressure dew point: <= +3°C→ Oil content: <=5mg/m³	

5.3.1. Compressed air supply for the cleaning of the filter cartridges

The filter cartridges of the system are automatically cleaned. Cleaning is carried out pneumatically via a built-in compressed air tank.

	Without compressed air supply the filter cartridges will become dirty very quickly.
---	---

- The external compressed air supply must be assured with an approved compressed air hose. For the connection to the device, the compressed air hose must be equipped with a quick coupling for an insert sleeve DN 7.2.

NOTICE The compressed air must be dry and oil-free.

- The operating pressure of the compressed air supply must be a minimum of 3 bars and maximum of 4 bars.



NOTICE In case of the pressure being too low, the compressed air tank does not reach quickly enough the operating pressure for the following cleaning. There is a risk of material damage when the pressure is too high.

- Connect the compressed air hose to the insert sleeve (see chapter 2.1).

6. Operating the system

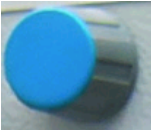
6.1. Explanation of the operating elements

Operating elements for the device control		
Representation	Designation	Description / function
	ON-OFF-switch	By means of this switch, the device is switched on and off. i When the device is switched off, it is <u>not</u> disconnected from the power supply.
	Potentiometer	The potentiometer can be used to set the speed and thus the air volume flow.

Operating elements for status and error messages		
Representation	Designation	Description / function
	Signal lamp "red"	Flashing up means that the air-flow rate of the device is not sufficient anymore. Filter elements must be cleaned or replaced. When using extraction elements with a suction hood, it is possible that the throttle valve(s) in the suction hood are closed. In this case open the throttle valves.
	Indicator lamp "green"	Flashing up means that the device is in operation.

6.2. Setting the automatic filter cartridge cleaning

The filter cartridge is cleaned automatically by means of the pulse generator (see chapter 2.1). For this purpose, a pneumatic cleaning is triggered after a preset time interval. The opening time controls the duration of the valve cleaning. The factory-set values can be changed if required:

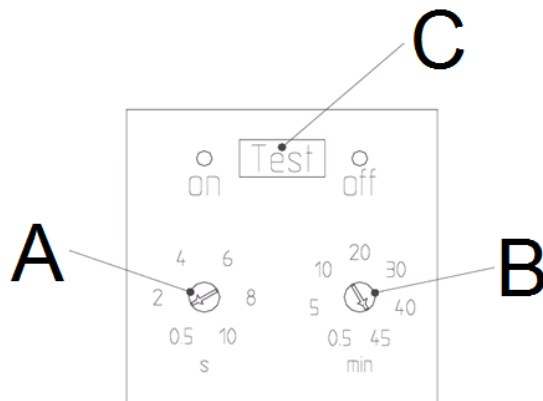

- **Time interval:** adjustable via controller "B".
- **Opening time:** adjustable via controller "A".
- **Manual cleaning:** pressing button "C" manually triggers a cleaning.

7. Maintenance

In accordance with national regulations, the operator is obliged to carry out repeat and functional tests. Unless otherwise specified by national regulations, we recommend regular visual inspections and functional tests of the device as described in the chapter "Maintenance intervals".



You find the chapter "Maintenance intervals" at the end of the document. The general maintenance (visual inspection, etc.) is also explained there.

In the chapter "Maintenance intervals" there is information on the maintenance intervals of the filter elements. But these are only recommendations. Depending on the application (multi-shift operation, dust generation, ...) it may be necessary for the operator to change the maintenance intervals.

In this chapter the maintenance work which is caused by wear caused during operation is described.



WARNING

Work on the open system entails the risk of electrical shock or accidental restart the system. Both pose a danger to life and limb.

When cleaning and servicing equipment during the replacement of parts or when changing to another function, set the device to maintenance condition first (see chapter "Reset to maintenance state").

A recommissioning of the device must only occur if it is ensured that the device is functionally equivalent to the original state.



CAUTION

Hazards to the respiratory tracts are possible.

All maintenance work must only be carried out in well-ventilated rooms and while wearing an appropriate respiratory mask! We recommend: respiratory protection half mask DIN EN 141/143 protection level P3. For all maintenance work ensure a cautious handling of filter elements and components in order to avoid whirling up dust.



The operator is obliged to store and dispose of the collected dust in accordance with national or regional regulations. For all maintenance or cleaning work please refer to the applying environmental regulations. Pollutants and filter elements must be disposed of or stored according to the regulations as well. If you have any doubts, we recommend contacting a disposal contractor in your area.

7.1. Reset to maintenance state

- Disconnect the compressed air hose of the external compressed air supply from the insert sleeve (see chapter 2.1).
- Empty the compressed air tank by pressing the "TEST" button of the pulse generator three times in a row.
- Switch off the unit. Unplug the mains plug. Secure the unit against unauthorized restarting during maintenance.
- After completion of all maintenance work the unit can be reconnected to the power supply and the external compressed air supply.

7.2. Cleaning the filter cartridges

The filter cartridges are reusable filters and can be cleaned. The cleaning of the filter cartridges is automatically carried out, according to a preset time interval.

The filter unit remains in operation during the automatic cleaning. The compressed air blast is produced in opposite direction to the intake. The cleaned dust falls downwards in the dust collecting tank.

When the maximal admissible differential pressure value is reached, the device triggers an alarm (see chapter "description of the control elements"). If despite of the automatic cleaning of the filter cartridge the alarm value is not undercut anymore, the filter cartridge must be replaced. (see chapter: "Replacing the filter cartridges").

7.3. Replacing the filter cartridges

Replacing the filter cartridges becomes necessary when the filter cartridges are saturated with dirt in a manner that despite of the cleaning the filter alarm is triggered again at very short intervals or permanently. (The filter alarm is described in chapter "Cleaning the filter cartridges".)

	CAUTION
<p>Whirling up dust is possible due to the polluted filter cartridges. The filter cartridges must be cleaned before being replaced. This is done by carrying out a manual cleaning three times. A manual cleaning is carried out by pressing the "TEST" button of the pulse generator. After the cleaning, disconnect the filter unit from the power supply and secure it against being switched on again.</p>	

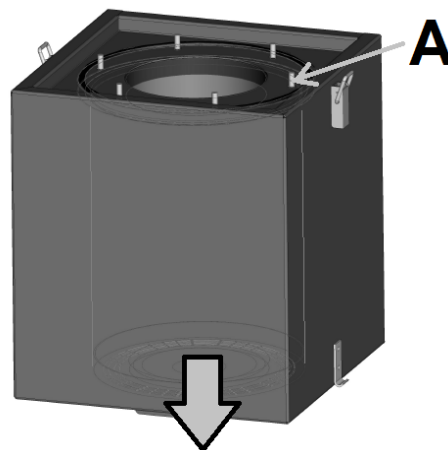

- Before changing the filter cartridges hold ready an appropriate container (e.g. PE bag) for disposal.
CAUTION The polluted filter cartridges must be packed into an appropriate container (e.g. PE bag).
- Open the toggle levers (see chapter 2.1). This allows the housing parts to be separated from each other.
- Loosen the 6 screws (A) on the top of the filter housing. Pull the filter cartridge downwards out of the filter housing.
- Insert the new filter cartridge and screw it in place.
NOTICE Only use TEKA spare filters. Otherwise the proper functioning of the unit is not guaranteed.
- Put the housing parts back on top of each other. Reconnect the housing parts by means of the toggle levers.

7.4. Emptying the dust collecting tank

The dust collection container must be cleaned after a certain number of operating hours. This range depends on the amount of dust. The filling level has to be proofed at least once a week.

	CAUTION
<p>Whirling up dust is possible due to the polluted filter cartridges. The filter cartridges must be cleaned before emptying the dust collecting tank. This is done by carrying out a manual cleaning three times. A manual cleaning is carried out by pressing the "TEST" button of the pulse generator. After the cleaning, disconnect the filter unit from the power supply and secure it against being switched on again.</p>	

- Open the lower toggle levers (see chapter 2.1). This allows the upper housing parts to be separated from the dust collecting tank.
- Carefully empty the dust from the dust collecting tank. Dispose of or store the dust according to the regulations.
- Put the housing parts back on top of each other. Reconnect the housing parts by means of the toggle levers.

7.5. Replacing the carbon brushes

The turbine must be checked after every 300 operating hours on carbon brushes which must be replaced if necessary. Please consider that replacement interval of the carbon brushes can vary. When turning on and off the unit frequently the collector of the turbine wears out differently what consequently has an influence on change interval of the carbon brushes. The turbine is subject to abrasive wear as well. Its average life span is about 600-800 operating hours.

- Remove the cover plate (see chapter 2.1).
- Pull the blade receptacle of the mains line out of the blade terminal of the carbon brush.
- Press the barb of the carbon brush down and withdraw the carbon brush.
- Insert the new carbon brush until the barb locks into place.
- Put the blade receptacle of the mains supply on the blade terminal of the new carbon brush.
- Mount the cover plate.

8. Dismantling / Disposal

Only authorised personnel may disassemble the machine.

	WARNING Dangers arising from electricity. Before the dismantling of the machine it has to be disconnected from the power supply and all supply lines.
---	---

	CAUTION Whirling up dust is possible due to the deposited dust. During all work a suitable respiratory protection and protective clothing have to be worn.
---	--

	The operator is obliged to store and dispose of the collected dust in accordance with national or regional regulations.
---	---

9. Diagnostics and troubleshooting

A list of possible system errors is provided in the table.

 Faults indicated by control elements are explained in the chapter "Description of the control elements".

A recommissioning of the device must only occur if it is ensured that the system is functionally equivalent to the original state. Repairs may only be carried out by TEKA personnel or, after consultation with TEKA GmbH, by the personnel authorised by the operator.

Adhere to the instructions in the chapter "Safety instructions" and "Maintenance" when carrying out any repairs. If in doubt, contact our TEKA service department:

Tel: +49 2541-84841-0
E-mail: info@teka.eu

Fault	Cause	Removal
System does not start.	Plug power supply is missing or incorrectly inserted.	Plug connector check power supply / plug in correctly.
	No power at outlet.	Check the mains, remove error if possible.
Suction power too low (smoke hardly extracted).	Filter element is saturated.	Replace the filter package, dispose of old filter properly!
	Filter elements are saturated because no compressed air is connected.	Connect compressed air.
	Damage at the extraction elements.	Replace the extraction elements.
	Suction line contracted.	Check and fix.
	Exhaust line contracted.	Check and fix.
	Maybe throttle valves are used in the suction line.	Adjust throttle valves.

10. List of spare parts

Filter element	Article no.
Filter cartridge, Type "PTFE", 1,2m ² (Ø218 x 305 mm)	9870003
Other parts	Article no.
Carbon brushes for AC turbine (2 pieces)	9870004

11. Technical data

Supply voltage	V	230
Frequency	Hz	50
Type of current	Ph	1
Engine power	kW	2x 0,8
Air flow volume max.	m³/h	340
Negative pressure max.	Pa	20.000
Protection class		IP54
ISO class		F
Extraction performance	%	> 99
Width	mm	300
Depth	mm	300
Height	mm	810
Weight	kg	25
Sound pressure level	dB(A)	74
Allowed ambient temperature	°C	+5 to +35 (during operations) -10 to +40 (during transport and storage)
Max. temperature of polluted air at the capture point	°C	+50
Allowed max. humidity	%	70
Compressed air supply		dry / oil-free
Necessary external pressure	bar	see chapter "Connecting the compressed air supply"

12. EC declaration of conformity

according to the Machinery Directive 2006/42/EG, Annex II, 1 A

TEKA Absaug- und Entsorgungstechnologie GmbH

Millenkamp 9, D-48653 Coesfeld

Tel.: +49 2541-84841-0

E-Mail: info@teka.eu

Internet: www.teka.eu

Designation of the device: dustoo

We hereby declare under our sole responsibility that the product mentioned above, from the serial number A22600010011001 resp. P57300010011001 on, conforms to the following directives:

Machinery Directive: 2006/42/EG

Electromagnetic Compatibility: 2014/30/EC

Pressure equipment directive: 2014/68/EU

RoHS directive: 2011/65/EU

This declaration will become void if the device is exposed to modifications that are not approved by the manufacturer in written form.

Authorized representative for the technical documentation:

TEKA Absaug- und Entsorgungstechnologie GmbH, Millenkamp 9, D-48653 Coesfeld

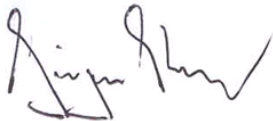

(Jürgen Kemper, managing director)

Coesfeld, 3rd January 2023



13. Training protocol

Designation of the device: dustoo

(This form can be used by the operator to document the training of the employees. Training should be performed by authorized personnel only. Refer to the instructions in Chapter "Safety Instructions")

By his signature, the employee confirms that he has been instructed regarding the following items:

Instruction	completed
Description of the device	
Operation and application of the device	
Explanation of the safety instructions	
Behavior in case of fire	
Explanation of the operation elements	
Change and dedusting of the filter elements	
Emptying of the dust collecting tank	
Appropriate disposal	
Maintenance works / Maintenance intervals	

Name of the employee (legible)	Signature

Introduction through (legible):	
Signature:	

14. Maintenance intervals

14.1. Usage-related maintenance

The described maintenances become necessary through the demands of the system operations. The maintenance intervals are recommendations. Depending on the application (multi-shift operation, dust generation, ...) it may make sense for the operator to change the intervals of maintenance, replacing and cleaning.

Maintenance work must always be documented by means of a protocol.

The approach of the maintenance measures is described in chapter "Maintenance".

Maintenance work	Chapter	Maintenance interval	
		recommended by TEKA	determined by the operator
Cleaning the filter cartridges	7.2	The cleaning of the filter cartridges is automatically carried out by the filter unit and thus is not subject to a maintenance interval.	
Replacing the filter cartridges	7.3	The saturation of the filter cartridges is automatically monitored by the filter unit and thus is not subject to a maintenance interval. The filter unit triggers an alarm when a replacement of the filter cartridges is necessary.	
Emptying the dust collecting tank (or check of fill level)	7.4	weekly	
Replacing the carbon brushes	7.5	approx. 300 operating hours	

14.2. General maintenance

The described maintenances are independent from the demands of the system operations.

The operator is obliged to carry out repeated inspections and functional tests according to national regulations. If not otherwise covered by national regulations, the described maintenance intervals must be respected.

Maintenance work must always be documented by means of a protocol.

Maintenance work	Chapter	Maintenance interval
Visual inspection of the device	14.2.1	weekly
Functional test of the device	14.2.2	monthly
Electrical test of the electrical lines and earthing connections	14.2.3	annually

14.2.1. Visual inspection of the device

Visual inspection: Observation that there are no visible safety-related defects.

	WARNING
Danger arising from the ready to operate condition of the device. Follow the procedure as described in the chapter "Set to maintenance state".	

The following steps must be carried out in the course of the visual inspection:

- Check if all required pipeline elements, cable connections and hoses are connected to the filter unit
- Ensure that all parts are firmly connected.
- Check all connection points of the filter unit for escaping dust.
- Check all metal parts for corrosion or damages / changes of the coating.
- Visual inspection of the control and operating elements as well as the outside running cables for damages.

14.2.2. Functional test of the device

	NOTICE
Possible material damage due to faulty condition of the unit. Carry out a visual inspection before the functional test of the device as described in the previous chapters. The work as described in the chapter "Commissioning" must be finished.	

The following steps must be carried out in the course of the functional test:

- Switch on the device.
- Pay attention to extraneous noises or vibrations during the device's operation.
- Check if dust is escaping from the unit during the dedusting cycle.
- A functional test should always be carried out with a connected / producing machine tool. Check if the collection of the fume or dust is sufficient. (Visual inspection).

14.2.3. Electrical test of the electrical lines and earthing connections

	WARNING
Danger arising from electricity. The operator is responsible for ensuring that all work on electric components is carried out by authorised and qualified personnel.	

The device is subject to regular electrical checks by the operator of the device, and are subject to national standards of the different countries.

The here recommended maintenance interval complies with the in Germany applying "Regulation 3 of the German Social Accident Insurance - Electrical plants and equipment" (formerly known as BGV-A3).

The check must only be carried out by a qualified electrician or a person trained in electrics using suitable measuring and test devices. The scope of testing and the methods must be in line with the respective national standard. All contacts in the control cabinet must be checked for tight fit, and must be readjusted if necessary.